



**ResMed**

**AirSense™ 11**

**AUTOSET**

**ELITE**



User guide  
English

# Contents

<b>Welcome</b> .....	<b>1</b>
Indications for use .....	1
Contraindications.....	1
Adverse effects .....	1
<b>Software functionality and device data</b> .....	<b>2</b>
<b>At a glance</b> .....	<b>3</b>
About your device .....	4
<b>Setting up your device</b> .....	<b>5</b>
<b>Navigating the touch screen</b> .....	<b>7</b>
Additional features .....	8
Connecting your AirSense 11 device and smart device .....	9
<b>Starting/Stopping therapy</b> .....	<b>10</b>
My Sleep View .....	10
<b>About the heated tubing</b> .....	<b>11</b>
<b>Therapy data</b> .....	<b>12</b>
<b>Cleaning and caring for the device</b> .....	<b>14</b>
Disassembling.....	15
Cleaning.....	15
Checking.....	16
Replacing the air filter.....	16
Reassembling .....	17
<b>Travelling</b> .....	<b>17</b>
Travelling by plane.....	17
<b>Troubleshooting</b> .....	<b>18</b>
<b>General warnings</b> .....	<b>20</b>
<b>Technical specifications</b> .....	<b>21</b>
<b>Symbols</b> .....	<b>25</b>
<b>Servicing</b> .....	<b>26</b>
<b>Limited Warranty</b> .....	<b>26</b>
<b>Further information</b> .....	<b>27</b>

## Quick setup view

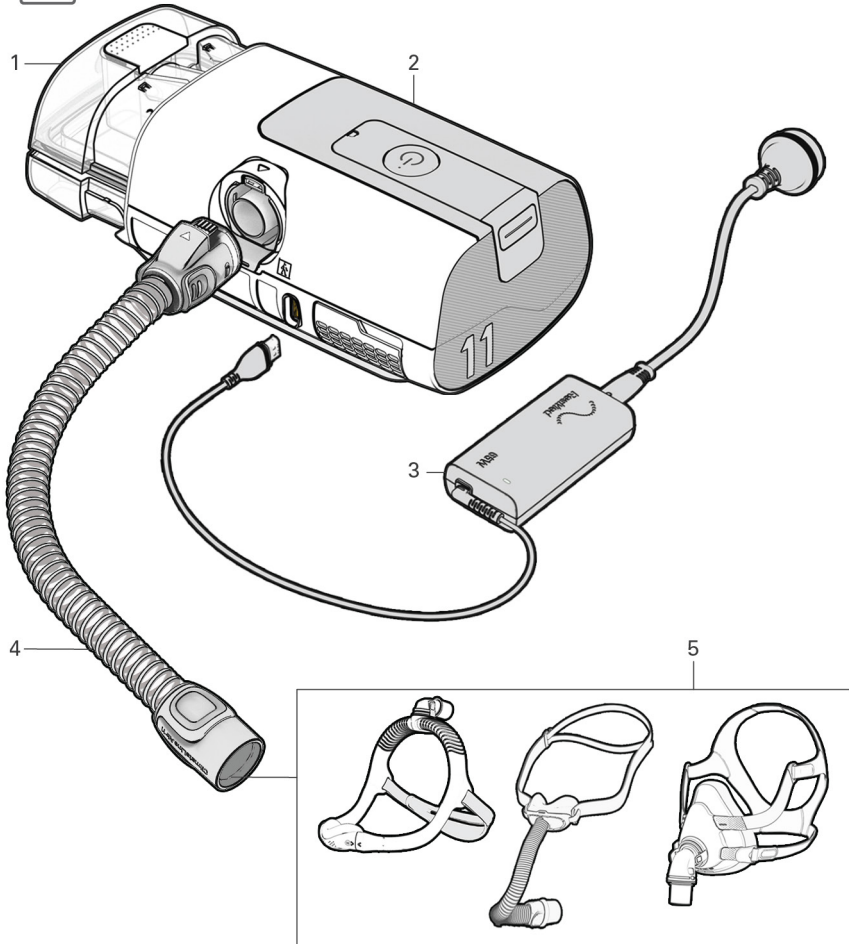

## Components

1. HumidAir™ 11 tub
2. AirSense™ 11 device
3. Power supply unit
4. ClimateLineAir™ 11 tubing
5. Mask

# Welcome

The AirSense 11 AutoSet™ (including AutoSet for Her) device is ResMed's auto-adjusting pressure device. The AirSense 11 Elite is ResMed's Continuous Positive Airway Pressure (CPAP) device.

## WARNING

- Read this entire guide before using the device.
- This device is not suitable for ventilator-dependent patients.

## Indications for use

### AirSense 11 AutoSet (including AutoSet for Her)

The AirSense 11 self-adjusting system is indicated for the treatment of obstructive sleep apnoea (OSA) in patients weighing more than 30 kg. The AirSense 11 self-adjusting system is intended for home and hospital use.

### AirSense 11 Elite (including CPAP)

The AirSense 11 Elite system is indicated for the treatment of obstructive sleep apnoea (OSA) in patients weighing more than 30 kg. The AirSense 11 Elite system is intended for home and hospital use.

### Hypoallergenic filter

The hypoallergenic filter provides air filtration during PAP (Positive Airway Pressure) therapy.

### HumidAir 11

The HumidAir 11 tub enables the provision of humidification. It is intended for home and hospital use.

## Contraindications

Positive airway pressure therapy may be contraindicated in some patients with the following pre-existing conditions:

- severe bullous lung disease
- pneumothorax or pneumomediastinum
- pathologically low blood pressure, particularly if associated with intravascular volume depletion
- dehydration
- cerebrospinal fluid leak, recent cranial surgery, or trauma.

## Adverse effects

You should report unusual chest pain, severe headache, or increased breathlessness to your prescribing physician. An acute upper respiratory tract infection may require temporary discontinuation of treatment.

The following side effects may arise during the course of therapy with the device:

- drying of the nose, mouth, or throat
- nosebleed
- bloating
- ear or sinus discomfort
- eye irritation
- skin rashes.

## Software functionality and device data

This ResMed device is a smart device and includes software functionalities which allow it to be connected to the cloud so that users and their care providers can access data about therapy remotely, receive regular upgrades to the device and much more. Check out <https://myair.resmed.com/> to learn about ResMed's patient coaching application, myAir™.

### Software License

**License Grant.** Subject to the terms and conditions below, ResMed grants you, the owner and/or user of this device, a perpetual, non-exclusive, non-sublicensable, personal, limited license to use the ResMed Software solely in connection with the use of this device. All other rights are reserved by ResMed. You will be deemed to have transferred and assigned this license to any person that acquires the owner's or the user's rights in this device.

**License Restrictions.** Software included on or with this device is owned by or licensed to ResMed (the "ResMed Software"). Neither the ResMed Software nor any intellectual property rights in the ResMed Software are sold or assigned by ResMed. No person or entity is licensed or authorized to (a) reproduce, distribute, create derivative works, modify, display, perform, decompile or attempt to discover the source code for the ResMed Software, (b) remove or attempt to remove the ResMed Software from the ResMed product, or (c) reverse engineer or disassemble the ResMed product or the ResMed Software. For avoidance of doubt, the foregoing restrictions are not intended to limit any licensee's rights to software code incorporated into or distributed with the ResMed Software and licensed under the terms of any open source, free or community software license (collectively, "Open Source Software").

**Over-the-Air Download of Software Updates.** If the device is connected to the cloud, then the ResMed Software on the device will automatically and periodically download updates and upgrades to the ResMed Software on the device. Such downloads may be done by various means including, but not limited to, using **Bluetooth®** wireless technology, WiFi and/or cellular networks and combinations of various wireless technologies and services. Such updates to the ResMed Software might include, without limitation, bug fixes, error corrections, security patches, and new versions and releases of the ResMed Software that may include changes to existing features or functions and/or the addition of new features and functions.

### Use of Device Data

When you use this device it gathers and records data about your use and, if your device connectivity is enabled, the device sends certain data to ResMed via the cloud to enable ResMed to deliver various benefits to you and your care provider(s). Additionally, some of that data may be used by ResMed (1) to comply with its legal obligations; these legal obligations include collection and analysis of device data for medical device post market surveillance and vigilance, and compliance with these legal obligations includes assessing if ResMed is required to implement actions to improve device safety, usability and performance, and (2) to perform health-related research, study and/or evaluation for specific scientific and medico-economic purposes. ResMed will only use your device data in compliance with applicable laws and regulations in your country or region (for example the GDPR (Regulation (EU) 2016/679 of the European Parliament and of the Council of 27 April 2016 on the protection of natural persons with regard to the processing of personal data and on the free movement of such data), the MDR (Regulation (EU) 2017/745 of the European Parliament and of the Council of 5 April 2017 on Medical Devices)) in the European Union, and, as applicable, HIPAA (the Health Insurance Portability and Accountability Act of 1996) in the USA). Depending on the data protection or privacy laws of your country or region your device data may constitute your personal data. If so, ResMed has the obligation to inform you about your rights and freedoms for our use of your personal data. You can find more details related to our use of your data, your rights to access, rectify, erase, restrict or object at <https://www.resmed.com/myprivacy/>.

# At a glance

## WARNING

Use only recommended ResMed masks and accessories or other vented masks as recommended by the prescribing doctor with this device. Using these components allows normal breathing and prevents potential asphyxiation.

The AirSense 11 system includes the following:

- Device
- HumidAir 11 Cleanable tub
- ClimateLineAir 11 heated tubing or SlimLine™ tubing
- Air 11™ Power supply unit: 65W AC adaptor
- Air11 filter
- Travel bag
- SD card (not available in all devices).

Contact your care provider or refer to the ResMed website (ResMed.com/productsupport) for a range of spares and compatible accessories available for use with the device including:

- Air tubing (ClimateLineAir 11, SlimLine and Standard 2m)
- HumidAir 11 Standard tub (Single patient re-use - cannot be reprocessed)
- HumidAir 11 Cleanable tub (Multi patient re-use - can be reprocessed)
- Side cover which allows use without the humidifier tub
- Air11 Filter - standard
- Air11 Filter - hypoallergenic
- Air11 DC/DC converter
- SD card
- SD card cover

### Notes:

- The AirSense 11 device is compatible with ResMed masks. For a complete list, see the Mask/Device compatibility list on ResMed.com/downloads/devices.
- The HumidAir 11 Standard tub and the HumidAir 11 Cleanable tub are the only water tubs used with the AirSense 11 device.
- The ClimateLineAir 11 is the only heated tubing that is compatible with the AirSense 11 device.

### Humidifier tubs

#### HumidAir 11 Standard tub

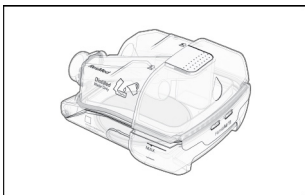

- single-patient use only
- cannot be reprocessed
- has a white thumb grip
- fill with distilled water only

#### HumidAir 11 Cleanable tub

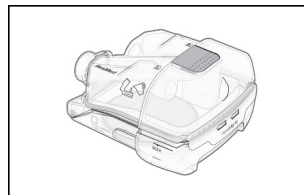

- multi-patient use
- can be reprocessed
- has a grey thumb grip
- fill with drinking quality water (potable)

## About your device

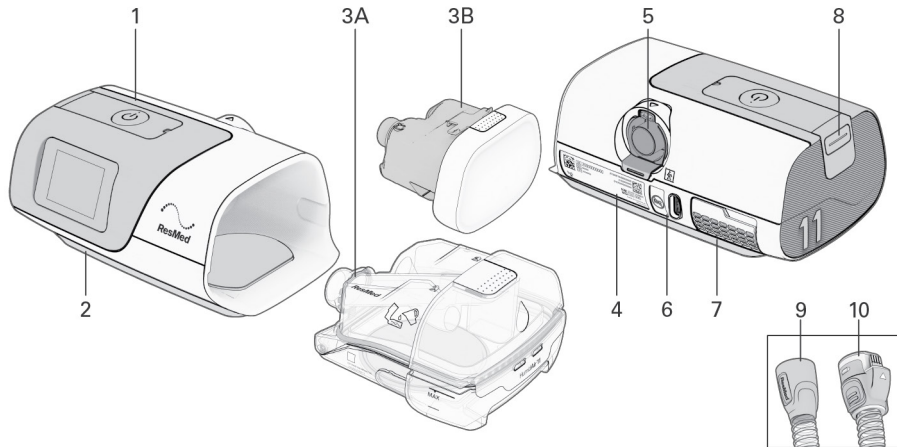

Description	Purpose
1 Start Therapy/ Standby button	Press to start/stop therapy. The LED indicator is green during standby mode, and white during therapy, <b>Test Drive</b> , and <b>Mask Fit</b> functions.
2 Display touch screen	Navigates between functions and displays information on the operating status of the device.
3 3A - HumidAir 11 tub 3B - Side cover	Water tub that provides heated humidification. For use without humidification.
4 Device label	Contains information relevant to the device.
5 Outlet connector	Connects the air tubing.
6 Power inlet	Connects the power cord.
7 Air inlet filter cover	Contains the air filter.
8 SD card cover	Removable cover that protects the SD card slot. The LED indicator is blue when data is written to the SD card.
9 SlimLine tubing	Non-heated air tubing.
10 ClimateLineAir 11 tubing	Heated air tubing.

### Notes:

- If the Start Therapy/ Standby button has a flashing white light, a system error has occurred. Refer to the Troubleshooting section for more information.
- Use this device only as directed by your physician or healthcare provider

# Setting up your device

## WARNING

Do not use any additives in the humidifier tub (eg, scented oils or perfumes). These may reduce humidification output and/or cause deterioration of the tub materials.

## CAUTION

Use only ResMed parts (eg, air inlet filter, power supplies), masks and accessories with the machine. Non ResMed parts may reduce the effectiveness of the treatment, may result in excess carbon dioxide rebreathing and/or damage the machine. For compatibility information, refer to ResMed.com for more information.

When using the humidifier tub:

- Always place the device on a level surface, lower than your head, to prevent the mask and air tubing from filling with water.
- Do not overfill the humidifier tub as water may enter the device and air tubing.
- Do not fill the humidifier tub with hot water as this could lead to excessive air temperature at the mask. Ensure the water is cooled to room temperature before filling the humidifier tub.
- Do not place the device on its side while the humidifier is attached as water might get into the device and reduce motor life.

When setting up the AirSense 11 system:

- Do not place the power supply where it can be bumped, stepped on, or where someone is likely to trip over the power cord.
- Do not block the air tubing and/or air inlet of the device while in operation as this could lead to overheating of the device.
- Keep the area around the device dry, clean and clear of anything (eg, clothes or bedding) that could block the air inlet or cover the power supply unit.
- Ensure the system is correctly set up. Incorrect system setup may result in incorrect mask pressure reading.

When using a mask:

- Use only vented masks recommended by ResMed or by the prescribing doctor with this device.
- Fitting the mask without the device blowing air can result in rebreathing of exhaled air.
- Make sure that the mask vent holes are kept clear and unblocked to maintain the flow of fresh air into the mask.



To set up the device:

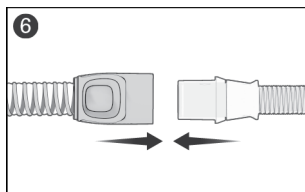
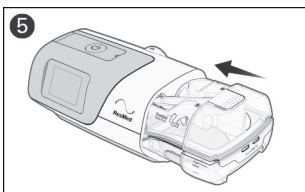
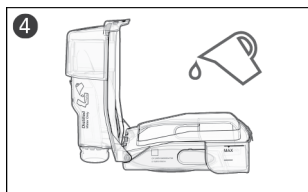
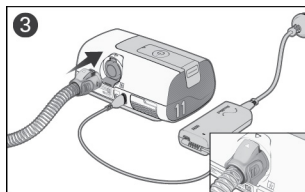
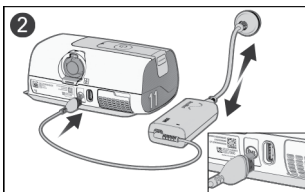
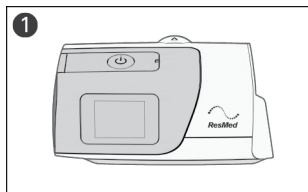

1. Place the device on a stable level surface.
2. Connect the power cord into the power inlet at the rear of the device. Connect one end of the power cord into the AC adaptor and the other end into the power outlet. Ensure the device is set up and connected to power to enable settings to be applied wirelessly to the device if required.
3. Connect the air tubing firmly to the outlet connector at the rear of the device.
4. Open the humidifier tub and fill it with water.  
**Note:** The humidifier tub must be removed from the device before adding water.
  - If using the HumidAir 11 Standard water tub, use distilled water only
  - If using the HumidAir 11 Cleanable water tub, use drinking quality water (potable).Fill the water tub up to the maximum water level mark. The humidifier tub has a maximum capacity of 380 mL.
5. Close the humidifier tub and insert it into the side of the device.
6. Connect the free end of the air tubing firmly onto the assembled mask.

See the mask user guide for detailed information.

Recommended masks for use with this device are listed on ResMed.com.









**Notes:**

- Do not insert any USB cable into the AirSense 11 device or attempt to plug the AC adaptor into a USB device. This may cause damage to the AirSense 11 device or USB device.
- The electrical connector end of the heated air tubing is only compatible with the air outlet at the device end and should not be fitted to the mask.
- Do not use electrically conductive or anti-static air tubing.

# Navigating the touch screen

The AirSense 11 device operates via a display touch screen, which allows you to access, view and change therapy and device settings. You can also track your sleep health progress.

The status bar at the top of the screen may display icons at different times and may include:

Icon	Description	Purpose
	Home Screen	Return to the Home screen at any time.
	Humidifier fault	Detects fault in the humidifier. Therapy will run without heating.
	Humidifier warming	Water in the humidifier tub is pre-heating.
	Humidifier cooling	Water in the humidifier tub is cooling.
	Bluetooth connected	Device is successfully connected via Bluetooth wireless technology.
	Cellular signal strength	Indicates the strength of cellular connectivity.
	No cellular connection	Cellular coverage is not available.
	Airplane mode	Device is in airplane mode.

## Initial Setup

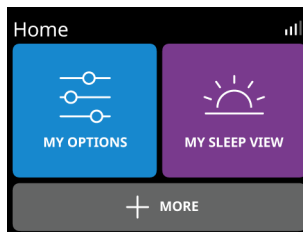
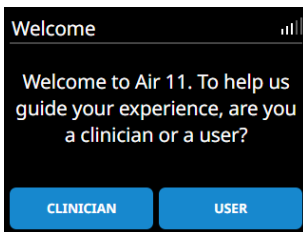

From the **Welcome** screen, tap **USER** and follow the prompts.

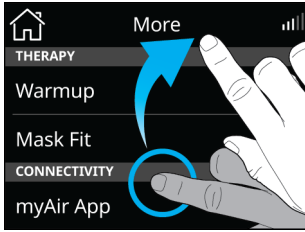

1. From the **Home** screen, you can access the following menus:
  - **MY OPTIONS**: View and adjust therapy settings (eg, Adjust Ramp time)
  - **MY SLEEP VIEW**: Track sleep health (check the number of hours used last night or mask status)
  - **MORE**: Access additional features such as Run Mask Fit or switch to Airplane mode.

Using the touch screen:



There are two actions to navigate through the touch screen:

**Swipe:** Swipe up or down the screen to view menu options.

**Tap:** Select a parameter setting to update. For other parameters (eg Pressure Relief, Airplane mode), tap the parameter to turn it on  or tap to turn it off .

### Prescription settings

If you have received the device direct to your home, prescription settings may not have been applied to your device. Ensure a wireless connection has been established to enable your care provider to install the prescribed settings.

### Personalizing your settings

The device can be set up for your needs by your care provider, but you may want to make adjustments to make your therapy more comfortable.

1. Tap **MY OPTIONS** from the **Home** screen.
2. Tap the parameter you wish to change.
3. Tap the preferred setting.



Tap **OK** to confirm the change or **CANCEL** to go back to the previous screen.

## Additional features

There are some other features on your device which you can personalise.

**Note:** Not all functions are available in all regions. Functions vary based on therapy mode.

Menu	Function	Description
MY OPTIONS	Ramp Time	Period during which the pressure increases from a low start pressure to the prescribed treatment pressure. Ramp Time can be set to Off, 5 to 45 minutes (in 5-minute increments), or Auto.
	Pressure Relief*	When EPR (Expiratory Pressure Relief) is enabled, you may find it easier to breathe out. This setting can help you get used to therapy.
	Mask	Allows you to select the type of mask used with the device.
	Tube	Allows you to select the type of tubing used with the device.
	SmartStart™*	When SmartStart is enabled, therapy starts automatically when you breathe into your mask.
	SmartStop*	When SmartStop is enabled, therapy stops automatically after a few seconds when you remove your mask.

Menu	Function	Description
MORE	Run Warmup	This function will heat the water in the humidifier tub
	Mask Fit	This function helps you assess and identify possible air leaks around your mask.  Indicates good mask seal. Leak is less than 24L/min.  Adjust the mask. Leak is more than 24L/min.
	Device Diagnostic	When enabled, Device Diagnostics will analyse the functionality of the device. See ResMed.com for further details. Device Diagnostic can be set to run Daily, Weekly, every 2 weeks, or it can be switched off.

\*Features enabled by your care provider.

## Connecting your AirSense 11 device and smart device

myAir is a smartphone app that guides you through the setup process. This includes device setup videos, mask fitting videos, trying therapy using the Test Drive feature, and tracking your sleep health progress. The app is not required to operate the AirSense 11 device.

Before pairing the AirSense 11 device to a smartphone, ensure the app's latest version is installed on the smartphone. If not, download the app from the App Store® or on Google Play®. Pair the AirSense 11 device to your phone. To set up the app, go to the **MORE** menu.

1. Ensure your AirSense 11 device is set up correctly and plugged into a power source.
2. Launch the myAir app. Tap **Continue**.
3. Follow the prompts on the myAir app to complete the Bluetooth connection.  
AirSense 11 is now connected to the app. The Bluetooth connection symbol appears on the status bar to confirm the connection between the AirSense 11 device and the smartphone.
4. Tap **Save**.

# Starting/Stopping therapy

## WARNING

The machine is not intended to be operated by persons (including children) with reduced physical, sensory or mental capabilities without adequate supervision by a person responsible for the patient's safety.

To start therapy:

1. Fit your mask
2. Press the Start therapy/Standby button or breathe normally if SmartStart is enabled

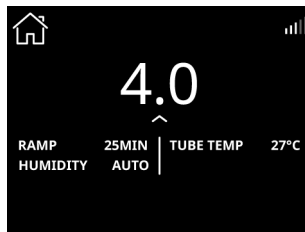
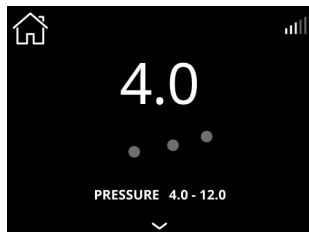

Therapy will begin and the treatment screen is displayed. A dynamic pulse wave will appear during therapy.

To review your sleep progress, click on  to view more details

### Notes:

- The screen will fade and then go black automatically after a short period of time. Tap the screen to turn it back on.
- If power is interrupted during therapy, the device will automatically restart therapy when power is restored.
- The device has a light sensor that adjusts the screen brightness based on the light in the room.

To stop therapy:

1. Remove your mask.
2. Press the Start therapy/Standby button or wait until the device stops if SmartStop is enabled.

## My Sleep View

Last night's sleep data can be found under **MY SLEEP VIEW**.

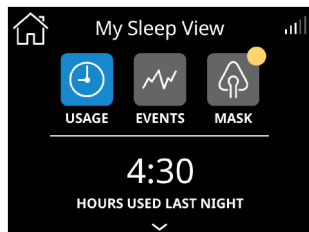

**USAGE:** displays HOURS USED LAST NIGHT

**EVENTS:** displays the number of apnoea and hypopnoea events per hour of sleep.

**MASK:** displays information on the mask seal. A yellow mark on this icon indicates there is information to view on the mask seal. Tap **MASK** to see more.

More detailed data can be found in myAir (if available). If enabled by your care professional, additional data may be found by tapping on .

# About the heated tubing

The ClimateLineAir 11 is a heated breathing tube that delivers air to a compatible mask. When used with the device humidifier tub, ClimateLineAir 11 heated air tubing allows you to use the Climate Control feature.

**Note:** Not all types of air tubing are available in all regions.

## Climate Control

Climate Control is designed to make therapy more comfortable by enabling constant temperature and maintaining humidity.

This feature:

- delivers comfortable humidity level and temperature during therapy
- maintains the set temperature and relative humidity during sleep to prevent dryness in the nose and mouth
- can be set to either **Auto** or **Manual**
- is only available when both the ClimateLineAir 11 and HumidAir 11 tub are attached.

## Climate Control - Auto setting

**Auto** is the recommended and default setting. It is designed to make therapy as easy as possible so there is no need to change the temperature or humidity settings.

- Sets the tube temperature to Auto (27°C). If the air in the mask is too warm or too cold, you can adjust the tube temperature to anywhere from 16 to 30°C or turn it off completely
- Adjusts the humidifier output to maintain a constant, comfortable humidity level of 85% relative humidity
- Protects against rainout (water droplets in the heated air tubing and mask).

## Climate Control - Manual setting

**Manual** is designed to offer more flexibility and control over settings and offers the following:

- Temperature and humidity can be adjusted to find the most comfortable setting
- Temperature and humidity level can be set independently
- Rainout protection is not guaranteed. If rainout does occur, first try increasing the tube temperature
- If the air temperature becomes too warm and rainout continues, try decreasing the humidity.

**Note:** If Climate Control is set to **Manual**, the **Auto** Tube Temperature setting is not available.

## Humidity Level

The humidifier moistens the air and is designed to make therapy more comfortable.

- If you are getting a dry nose or mouth, turn up the humidity
- If you are getting any moisture in your mask, turn down the humidity.
- You can set the **Humidity Level** to Off or between 1 and 8, where 1 is the lowest humidity setting, and 8 is the highest humidity setting.

To update the setting for **Tube Temperature**, **Climate Control**, or **Humidity Level**, tap **MY OPTIONS** from the **Home** screen, go down the list of options, and select the setting.

**Note:** Tube Temp **Auto** setting is only relevant when using the **Climate Control Auto** setting. If **Climate Control** is set to **Manual**, **Auto** set temperature is not a valid selection.

### Tube Temperature

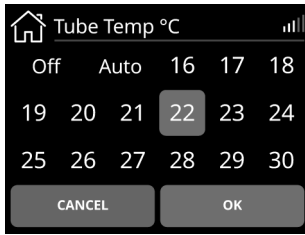

1. Tap **Tube Temp**.
2. Tap the preferred setting.
3. Tap **OK** to save the change.

### Climate Control



1. Tap **Climate Control**.
2. Tap **Manual**.
3. Tap **OK** to save the change.

### Humidity Level

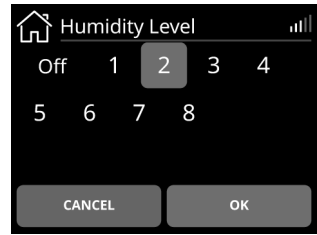

1. Tap **Humidity Level**.
2. Tap the preferred setting.
3. Tap **OK** to save the change.

Note: The temperature and humidity settings are not measured values.

## Therapy data

The AirSense 11 device records your therapy data for viewing and adjusting by your care provider if required. The data is transferred to your care provider in the following methods:

### Wireless

The device is equipped with cellular communication that allows your sleep therapy data to be wirelessly transmitted to your care provider. It also allows for prescribed settings to be applied or updated.

Transfer of data will occur after therapy has stopped. Leave your device connected to the power outlet at all times and make sure it is not in Airplane Mode. Data will only be transferred if a wireless connection is available.

Within the wireless network, the availability and quality of the network may be affected by terrain, buildings, and the weather. Wireless communication depends on network availability. Coverage is not available everywhere and varies by service.

### Notes:

- Cellular feature may not work/ therapy data might not be transmitted if you use it outside of the country or region of purchase.
- Devices with cellular communication might not be available in all regions.

### SD card

Your sleep therapy data may be transferred to your care provider via SD Card (if provided). Your care provider may ask you to send the SD card by mail or to bring it in. Only remove the SD card when instructed by your care provider.

To use the SD card to record your sleep data, remove the SD card cover.

Do not remove the SD card from the device when the SD light is flashing, because data is being written to the card.

**Note:** The SD card should not be used for any other purpose as it may corrupt therapy data stored on the card.

To remove the SD card cover and insert SD card:

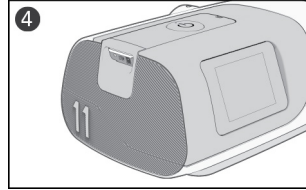
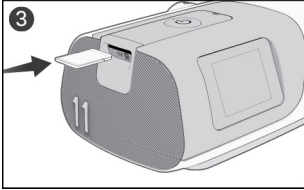
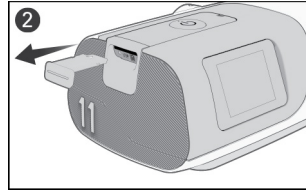
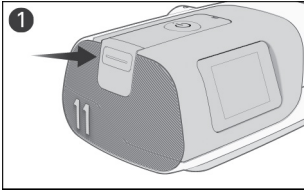

1. Push the SD card cover.
2. Remove the SD card cover and keep the SD card cover in a safe place.
3. Insert the SD card.
4. Push in the SD card until it clicks in place.

**To remove the SD card:**

1. Push in the SD card to release it.
2. Place the SD card in the protective folder and follow your care provider's instructions.

For more information on the SD card, refer to the SD card protective folder provided with your device.



## Cleaning and caring for the device

### WARNING

- Beware of electrocution:
  - Do not immerse the device, AC Adaptor or power cord in water.
  - Do not connect to power while the device is wet. Make sure that all parts are dry before plugging it in.
  - If liquids are spilled into or onto the device, unplug the device and let the parts dry.
- Always unplug the device before cleaning and ensure that all parts are dry before plugging it back in.
- Do not perform any maintenance tasks (eg, cleaning, changing the air filter) while the device is in operation.
- Clean the device and its components according to the schedules shown in this guide, to maintain the quality of the device and to prevent the growth of germs that can adversely affect your health.
- Regularly inspect power cords, cables, and power supply for damage or signs of wear. Discontinue use and replace if damaged.
- Do not open or modify the device. There are no user serviceable parts inside. Repairs and servicing should only be performed by an authorised ResMed service agent.

### CAUTION

- Do not use bleach, chlorine, or aromatic-based solutions, moisturising or antibacterial soaps or scented oils to clean the device, the humidifier tub or air tubing. These solutions may cause damage or affect the humidifier performance and reduce the life of the products. Exposure to smoke, including cigarette, cigar or pipe smoke, as well as ozone or other gases, may damage the device. Damage caused by any of the foregoing, will not be covered by ResMed's limited warranty.
- Leave the humidifier tub to cool for at least ten minutes after turning off the humidifier or until the cool down mode is complete before handling the humidifier tub.
- Only clean, maintain and/or reprocess the device and components according to the instructions shown in this guide.

The following sections will help you with:

- Disassembling
- Cleaning
- Checking
- Reassembling.

## Disassembling

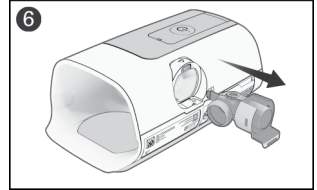
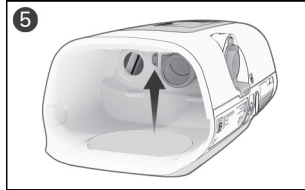
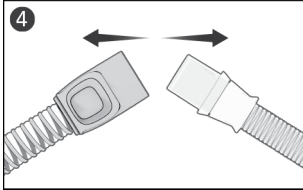
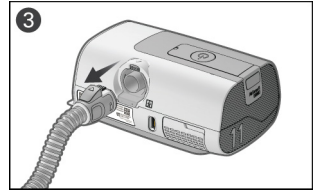
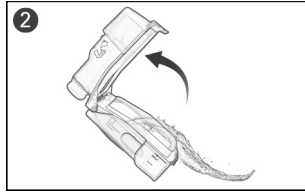
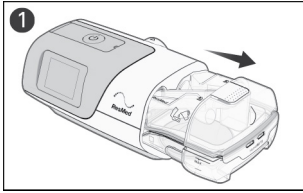

1. Hold the humidifier tub at the top and bottom, press it gently and pull it away from the device.  
**Note:** take care when handling the humidifier tub as the humidifier tub may be hot. Allow 10 minutes for the heater plate and any excess water to cool.
2. Open the humidifier tub and discard any remaining water.
3. Pinch the cuff of the air tubing, and gently pull it away from the device.
4. Hold both the cuff of the air tubing and the swivel of the mask, then gently pull apart.
5. Locate the outlet connector on the inside of the device and release it by pressing the clip firmly.
6. Remove the outlet connector by pulling it out through the outlet connector socket at the rear of the device.

## Cleaning

The following instructions are for home cleaning. Instructions for reprocessing devices intended for multi-patient re-use can be found in the clinical guide.

You should clean the device, humidifier tub, air tubing, and outlet connector as described. For cleaning your mask, refer to the mask user guide for detailed instructions.

### Daily:

1. Empty the humidifier tub and wipe it thoroughly with a clean disposable cloth. Allow it to dry out of direct sunlight.
2. Refill the humidifier tub.
  - If using the HumidAir 11 Standard water tub, use distilled water only
  - If using the HumidAir 11 Cleanable water tub, use drinking quality water (potable).

### Weekly:

1. Wash the components as described:
  - Air tubing - in warm water using a mild dishwashing liquid.
  - Humidifier tub - in warm water using a mild dishwashing liquid OR in a solution with a ratio of 1 part vinegar and 9 parts water at room temperature.
  - Outlet connector - in warm water using a mild dishwashing liquid OR in a solution with a ratio of 1 part vinegar and 9 parts water at room temperature.
  - Components should not be washed in temperatures higher than 131°F (55°C).
2. Rinse each component thoroughly in water.
3. Allow to dry out of direct sunlight or heat
4. Wipe the exterior of the device with a dry cloth.

## Notes:

- The humidifier tub and outlet connector may be washed in a dishwasher. It should not be washed at temperatures higher than 65°C.
- Do not wash the air tubing in a dishwasher or washing machine.
- The air filter is not washable or reusable.

## Checking

### WARNING

- Discontinue use and contact your care provider or ResMed Service Centre if any of the following occur:
  - device does not perform as usual
  - device is making unusual sounds
  - device is damaged
- If using a bacterial/viral filter, regularly check it for signs of moisture or other contaminants, particularly during nebulization or humidification. Failure to do so could result in increased breathing resistance or affect the delivery of the therapeutic pressure.

### CAUTION

If any visible deterioration of a system component is apparent (cracking, discoloration, tears etc.), the component should be discarded and replaced.

Regularly check the humidifier tub, air tubing, and air filter for any damage.

1. Check the humidifier tub:
  - Replace it if it is leaking or has become cracked, cloudy, or pitted.
  - Replace it if the seal is cracked or torn.
  - Remove any white powder deposits using a solution of 1 part household vinegar to 9 parts water. Rinse with clean water.
2. Check the air tubing and replace it if there are any holes, tears, or cracks.
3. Check the air filter and replace it every six months. Replace it more often if there are any holes or blockages by dirt or dust.

## Replacing the air filter

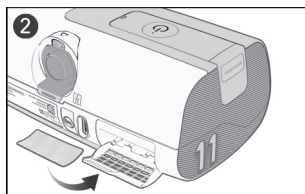
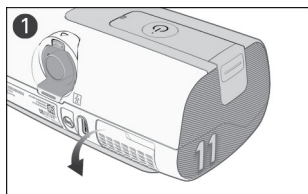

1. Open the air filter cover and remove the old air filter.
2. Place a new air filter onto the air filter cover and then close the cover. Make sure the air filter and air filter cover are fitted at all times to prevent water and dust from entering the device.

**Note:** The air filter is not washable or reusable.

## Reassembling

When the components are dry, you can reassemble the parts.

### To reassemble the AirSense 11 system:

1. Hold the outlet connector with the seal pointing to the left and the clip pointing forward.
2. Make sure the outlet connector is correctly aligned and insert the outlet connector into the socket.
3. Check the outlet connector is inserted correctly.
4. Connect the air tubing firmly to the air outlet located on the rear of the device.
5. Open the humidifier tub and fill it with water up to the maximum water level mark.
  - If using the HumidAir 11 Standard water tub, use distilled water only
  - If using the HumidAir 11 Cleanable water tub, use drinking quality water (potable)
6. Close the humidifier tub and insert it into the side of the device.
7. Connect the free end of the air tubing firmly onto the assembled mask.

## Travelling

You can take your device with you wherever you go. Just keep the following in mind:

- Use the travel bag provided to prevent damage to the device.
- Empty the humidifier tub and pack it separately in the travel bag.
- Make sure you have the appropriate power cord for the region you are travelling to. For information on purchasing, contact your care provider.

### Travelling by plane



#### WARNING

- Do not use the device with water in the humidifier tub while in transit (eg, on a plane or vehicle) due to the risk of:
  - water spilling into the device
  - the inhalation of water during turbulence.
- Make sure that the humidifier tub is empty before transporting the device.

Your AirSense 11 device may be taken on board as carry-on luggage. Medical devices do not count toward your carry-on luggage limit.

You can use your AirSense 11 device on a plane as it meets the Federal Aviation Administration (FAA) requirements. Air travel compliance letters can be downloaded and printed from [www.resmed.com](http://www.resmed.com).

When using the device on a plane:

- Make sure the humidifier tub is empty and inserted into your device. The device will not work without the humidifier tub or side cover inserted.
- Make sure the device is switched to airplane mode when required by airline staff.



### To turn on Airplane mode:

1. From the Home screen, tap **MORE**.
2. Swipe through the menu to locate **Airplane Mode**.
3. Tap **Airplane Mode** to switch it on.

# Troubleshooting



If you have any problems, have a look at the following troubleshooting topics. If you are not able to fix the problem, contact your care provider or ResMed. Do not try to open the device.

## General Issues

Problem/possible cause	Solution
<b>Air is leaking from around my mask</b> Mask may be fitted incorrectly.	Make sure your mask is fitted correctly. See your mask user guide for fitting instructions, run the mask fit function or refer to the Mask Fit video in the myAir app.
<b>I am getting a dry or blocked nose</b> Humidity level may be set too low.	Increase the <b>Humidity Level</b> .
<b>I am getting droplets of water on my nose, in the mask and air tubing</b> Humidity level may be set too high. Tube temperature may be too low.	Decrease the <b>Humidity Level</b> . Increase the <b>Tube Temperature</b> .
<b>My mouth is very dry and uncomfortable</b> Air may be escaping through your mouth.	You may need a chin strap to keep your mouth closed or a full face mask.
<b>My screen is black</b> Power may not be connected.	Connect the AC adaptor and make sure the plug is fully inserted.
<b>My humidifier tub/side cover is leaking</b> Humidifier tub may not be assembled correctly. Side cover may not be inserted correctly. Humidifier tub/side cover may be damaged or cracked.	Check for damage and reassemble the humidifier tub correctly. Check the side cover to ensure it has been inserted correctly. It should click in place. Contact your care provider for a replacement.
<b>My therapy data has not been sent to my care provider/prescription settings have not been applied to my device</b> Cellular coverage may be poor/The no cellular connection icon  is displayed on the top right of the screen. Device may be in Airplane Mode. Data transfer is not enabled for your device.	Make sure that the device is placed where there is coverage (ie, on your bedside table, not in a drawer or on the floor). Wireless communication depends on network availability. The cellular signal strength icon  indicates good coverage when all bars are displayed, and poor coverage when fewer bars are displayed. Turn off <b>Airplane Mode</b> . Talk to your care provider about your settings.
<b>SmartStart is enabled, but the device does not automatically start when I breathe into the mask</b> Breath is not deep enough to trigger SmartStart There is excessive leak	To start therapy, take a deep breath in and out through the mask, before breathing normally. Press the Start therapy/Standby button located on top of the device. Adjust the mask and headgear Air tubing may not be connected properly. Connect firmly at both ends.

Problem/possible cause	Solution
<b>SmartStop is enabled, but does not automatically stop when I remove the mask.</b>	
Incompatible mask being used	Only use equipment recommended by ResMed. Contact ResMed or see ResMed.com for more information. If you are using a conduit mask, SmartStop may not work.

### Device Messages

Problem/possible cause	Solution
<b>High leak detected. Check your humidifier or side cover.</b>	
Humidifier tub or side cover may not be inserted properly	Make sure the humidifier tub or side cover is correctly inserted
<b>High leak detected. Connect your tubing.</b>	
Air tubing may not be connected properly.	Make sure the air tubing is firmly connected at both ends.
Mask may be fitted incorrectly.	Make sure the mask is fitted correctly. See the mask user guide for fitting instructions or use the <b>Mask Fit</b> function to check the mask fit and seal.
<b>Tubing blocked. Check your tubing.</b>	
Air tubing may be blocked	Check the air tubing and remove any blockages. Press the Start therapy/standby button to restart the device
<b>Read only card, remove, unlock and re-insert SD card</b>	
SD card switch may be in the lock (read-only) position	Move the switch on the SD card from the lock position  to the unlock position and  then re-insert it.
<b>System fault, refer to user guide, Error 4</b>	
Device may have been left in a hot environment	Allow to cool before re-use. Disconnect the AC adaptor and then reconnect it to restart the device.
Air filter may be blocked	Check the air filter and replace it if there are any blockages. Disconnect the AC adaptor and then reconnect it to restart the device.
There may be water in the air tubing	Empty the water from the air tubing. Disconnect the AC adaptor and then reconnect it to start the device.
<b>System fault, refer to user guide, Error X</b>	
An error has occurred on the device.	Remove power and restart device. If error persists, contact your care provider or ResMed. Do not open the device.

## General warnings

### WARNING

- Supplemental oxygen must not be used while smoking or in the presence of an open flame.
- When using the device with an oxygen supply, check the following:
  - Starting therapy – ensure the device is on and blowing air before the oxygen supply is turned on.
  - Stopping therapy – ensure the oxygen supply is turned off first, then the device.  
This will ensure oxygen does not accumulate within the device and create a risk of fire.
- The device has not been tested or certified for use in the vicinity of X-ray, CT or MRI equipment. Do not bring the device within 4 m of X-ray or CT equipment. Never bring the device into an MR (Magnetic Resonance) environment.
- The device should not be used adjacent to or stacked with other equipment. If adjacent or stacked use is necessary, the device should be observed to verify normal operation in the configuration in which it will be used.
- The use of accessories other than those specified for the device is not recommended. These may increase radio frequency energy or be influenced by the interference and result in improper operation.
- Portable RF communications equipment (including peripherals such as antenna cables and external antennas) should be used no closer than 10 cm to any part of the device. Otherwise, degradation of the performance of this equipment could result.

For any serious incidents that occur in relation to this device, these should be reported to ResMed and the competent authority in your country.

# Technical specifications

## Operating pressure range

4 to 20 cm H<sub>2</sub>O (4 to 20 hPa)

## Maximum single fault steady state pressure

Device will shut down in the presence of a single fault if the steady state pressure exceeds: 40 cm H<sub>2</sub>O (40 hPa) for more than 1 second.

## Pressure measurement tolerance

± 0.5 cm H<sub>2</sub>O (0.5 hPa) ±4% of measured reading

## Flow measurement tolerance

± 6 L/min or 10% of reading, whichever is greater, at 0 to 150 L/min positive flow

## Mode pressure ranges

CPAP: 4-20 cm H<sub>2</sub>O (4-20 hPa) (measured at the mask)

CPAP with EPR mode: 4-20 cm H<sub>2</sub>O (4-20 hPa) CPAP with EPR settings: EPR off, Level 1 = 1.0 cm H<sub>2</sub>O (1 hPa), Level 2 = 2.0 cm H<sub>2</sub>O (2 hPa), Level 3 = 3.0 cm H<sub>2</sub>O (3 hPa).

AutoSet, AutoSet for Her mode: 4-20 cm H<sub>2</sub>O (4-20 hPa)

AutoSet, AutoSet for Her mode with EPR: 4-20 cm H<sub>2</sub>O (4-20 hPa) APAP with EPR settings: EPR off, Level 1 = 1.0 cm H<sub>2</sub>O (1 hPa), Level 2 = 2.0 cm H<sub>2</sub>O (2 hPa), Level 3 = 3.0 cm H<sub>2</sub>O (3 hPa).

EPR reduces the pressure during expiration by the amount dependant on the level set above, but the pressure delivered will not drop below 4.0 cm H<sub>2</sub>O (4 hPa).

## Flow (maximum) at set pressures

The following are measured according to ISO 80601-2-70:2015 and ISO 80601-2-70:2020.

With HumidAir 11 tub

Pressure cm H <sub>2</sub> O (hPa)	AirSense 11 and Standard air tubing L/min	AirSense 11 and SlimLine L/min	AirSense 11 and ClimateLineAir 11 L/min
4	150	145	144
8	147	142	141
12	143	138	138
16	140	135	134
20	136	131	129

With Side cover

Pressure cm H <sub>2</sub> O (hPa)	AirSense 11 and Standard air tubing L/min	AirSense 11 and SlimLine L/min	AirSense 11 and ClimateLineAir 11 L/min
4	156	153	151
8	152	147	147
12	149	145	144
16	144	141	139
20	140	136	135

**Note:** Refer to the relevant measurement uncertainty from the Measurement system uncertainties table.

## Sound

Declared dual-number noise emission values in accordance with ISO 4871:1996

Sound pressure level measured according to ISO 80601-2-70:2020 (CPAP mode):

Device with SlimLine and HumidAir 11 tub (HumidAir 11 tub 1/2 filled) 27 dBA with uncertainty of 2 dBA

Device with SlimLine and Side cover 25 dBA with uncertainty of 2 dBA



Sound power level measured according to ISO 80601-2-70:2020 (CPAP mode):

Device with SlimLine and HumidAir 11 tub (HumidAir 11 tub 1/2 filled)	35 dBA with uncertainty of 2 dBA
Device with SlimLine and Side cover	33 dBA with uncertainty of 2 dBA

---

### Physical Dimensions

Dimensions (H x W x D) with HumidAir 11 tub:	94.5 mm x 259.4 mm x 138.5 mm
Dimensions (H x W x D) with side cover	94.5 mm x 236.8 mm x 138.5 mm
Air outlet:	The 22 mm conical outlet connector complies with EN ISO 5356-1:2015
Weight - device and HumidAir 11 tub:	1130 g
Weight - device with side cover	1142 g
Housing construction:	Flame retardant engineering thermoplastic
Hot plate - Material:	Stainless steel
Water capacity:	380 mL
Time between each refill of the humidifier tub:	> 8 hours $\pm$ 0.5 hours (tested at 23 $\pm$ 2°C)
Recommended water type to use in the humidifier tub (Standard tub):	Distilled water
Recommended water type to use in the humidifier tub (Cleanable tub):	Drinking quality water (potable)
Humidifier tub - Material:	Injection moulded plastic, stainless steel and silicone seal

---

### 65W power supply unit

AC input range	100-240V, 50-60Hz, 2.0A 115V, 400Hz, 1.5A (for aircraft use)
DC output	24 V  2.71A
Typical power consumption	56.1W (111.5VA)
Peak power consumption	73.2W (137.6VA)
Class of equipment	Class II

---

### Environmental conditions

Operating temperature	+5°C to +35°C <b>Note:</b> The airflow for breathing produced by this therapy device can be higher than the room temperature. Under extreme ambient temperature conditions (40°C) the device remains safe.
Operating humidity	10 to 95% relative humidity, non-condensing
Operating altitude	Sea level to 9,870' (3,010 m); air pressure range 1060 hPa to 700 hPa
Storage pressure/Storage altitude	1060 to 700 hPa
Storage and transport temperature	-25°C to +70°C
Storage and transport humidity	5 to 95% relative humidity, non-condensing

---

### Air Filter

Standard:	Material: Polyester non woven fibre Average arrestance: >75%, when tested to EN779.
Hypoallergenic:	Material: Blended synthetic fibres in a polypropylene carrier Efficiency: >80% (average) when tested to EN13274-7. <b>Note:</b> The use of a ResMed approved hypoallergenic filter will result in a small reduction in the accuracy of the delivered pressure at high leaks.

---

### Electromagnetic compatibility

The AirSense 11 complies with all applicable electromagnetic compatibility requirements (EMC) according to IEC 60601-1-2:2020, for residential, commercial and light industry environments.

Portable and mobile RF communications equipment should be used no closer to any part of the machine, including cables, than the recommended 10 cm separation distance.

The AirSense 11 has been designed to meet EMC standards. However, should you suspect that the device performance (eg. pressure or flow) is affected by other equipment, move the device away from the possible cause of interference.

Information regarding the electromagnetic emissions and immunity of this ResMed device can be found in [ResMed.com/downloads/devices](https://www.resmed.com/downloads/devices).

---

### IEC 60601-1 (Edition 3.1) classification

Class II (double insulation), Type BF, Ingress protection IP22.

---

### Supplemental oxygen maximum flow

15 L/min

---

### Aircraft use

ResMed confirms that the machine meets the Federal Aviation Administration (FAA) requirements (RTCA/DO-160, section 21, category M; RTCA-DO-160, section 20, category T) for all phases of air travel.

---

### Design life

Device, power supply unit:	5 years
Standard humidifier tub:	6 months
Cleanable humidifier tub:	2.5 years
Air tubing:	6 months

---

### General

The patient is an intended operator.

---

### Pneumatic flow path

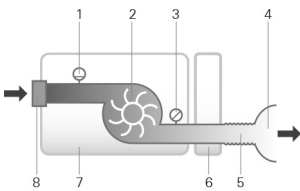

1. Flow sensor
  2. Blower
  3. Pressure sensor
  4. Mask
  5. Air tubing
  6. Humidifier
  7. Device
  8. Inlet filter
- 

### Displayed values

Value	Range	Accuracy	Display resolution
Pressure at mask:			
Displayed mask pressure <sup>1</sup>	4-20 cm H <sub>2</sub> O (4-20 hPa)	±0.5 cm H <sub>2</sub> O (0.5 hPa) ±4% of measured reading	0.1 cm H <sub>2</sub> O (0.1 hPa)
Flow derived values:			
Leak <sup>1</sup>	0-120 L/min	± 12 L/min or 20% of reading whichever is greater, 0 to 60 L/min	1 L/min

---

<sup>1</sup> Results may be inaccurate in the presence of leaks or supplemental oxygen

### Pressure accuracy - CPAP mode

Maximum static pressure variation at 10 cm H<sub>2</sub>O (10 hPa) according to ISO 80601-2-70:2015 and ISO 80601-2-70:2020  
Device with HumidAir 11 humidifier tub / side cover and air tubing: ±0.5 cm H<sub>2</sub>O (±0.5 hPa)

---

### Maximum dynamic pressure variation according to ISO 80601-2-70:2015

Device with HumidAir 11 humidifier tub / side cover and air tubing:

Breath rate	10 BPM	15 BPM	20 BPM
Dynamic pressure variation (cm H <sub>2</sub> O [hPa])	0.5	0.5	0.8

### Maximum dynamic pressure variation according to ISO 80601-2-70:2020

Device with HumidAir 11 humidifier tub / side cover and air tubing:

Maximum error from set pressure (cm H<sub>2</sub>O [hPa]): ±1

**Note:** Refer to the relevant measurement uncertainty from the Measurement system uncertainties table.

### Measurement system uncertainties

In accordance with ISO 80601-2-70:2020 the measurement uncertainty of the manufacturer's test equipment is:

For measures of flow:	± 3.9 L/min
For measures of static pressure:	± 0.15 cm H <sub>2</sub> O (± 0.15 hPa)
For measures of dynamic pressure:	± 0.15 cm H <sub>2</sub> O (± 0.15 hPa)

**Note:** ISO 80601-2-70 stated accuracies and test results provided in this manual for these items already include the relevant measurement uncertainty from the table above.

In accordance with ISO 80601-2-74:2021 the measurement uncertainty of the manufacturer's test equipment is:

For measures of humidification output	± 0.5 mg/L BTPS
---------------------------------------	-----------------

### Bluetooth

Technology used:	Bluetooth Low Energy (BLE)
Connection types:	GATT
Frequency:	2400 to 2483.5 MHz
Max RF power output:	+4 dBm
Operation range:	10 m (Class 2)

### Cellular technology and regulatory compliance

Refer to the Cellular information guide in [ResMed.com/downloads/devices](https://www.resmed.com/downloads/devices).

The device should be installed and operated with minimum distance 15 mm between the equipment and the user's body.

### Humidifier

Maximum heater plate temperature:	68°C
Temperature cut-out (heater):	74°C
Maximum gas temperature (at mask) <sup>1</sup> :	≤ 41°C

<sup>1</sup> The air flow for breathing produced by this therapy device can be higher than the temperature of the room. Under extreme ambient temperature conditions (40°C) the device remains safe.

### Humidifier performance

#### SlimLine/Standard tubing

Mask Pressure cm H <sub>2</sub> O (hPa)	Nominal RH output % at 22°C ambient temperature		Nominal system output mg/L AH <sup>1</sup> , BTPS <sup>2</sup>	
	Setting 4 (default setting)	Setting 8 (maximum setting)	Setting 4 (default setting)	Setting 8 <sup>3</sup> (maximum setting)
4	80%	100%	≥6	>12
10	80%	100%	≥6	>12
20	80%	100%	≥6	>12

## Climate Control Auto - ClimateLineAir 11

Mask Pressure cm H <sub>2</sub> O (hPa)	Nominal RH output % at 22°C ambient temperature	Nominal system output mg/L AH <sup>1</sup> , BTPS <sup>2</sup>
4	85%	≥ 12
10	85%	≥ 12
20	85%	≥ 12

<sup>1</sup> AH - Absolute Humidity in mg/L

<sup>2</sup> BTPS - Body Temperature Pressure Saturated

<sup>3</sup> Humidifier performance meets ISO 80601-2-74:2017 performance > 12 mg/L BTPS tested at 15°C to 35°C

### Air tubing



	ClimateLineAir 11	SlimLine/ Standard
ClimateLineAir 11 temperature range	16 to 30°C	-
ClimateLineAir 11 temperature cut out	≤41°C	-
Maximum recommended pressure	30 cm H <sub>2</sub> O (30 hPa)	30 cm H <sub>2</sub> O (30 hPa)
Maximum working temperature, when used with a humidifier	-	≤41°C
Material	Flexible plastic and electrical components	Flexible plastic
Inner diameter	15 mm	SlimLine: 15 mm Standard: 19 mm
Length	2.0 m	SlimLine: 1.8 m Standard: 2.0 m





**Note:** The manufacturer reserves the right to change these specifications without notice.





### Air tubing resistance to flow and compliance information





Refer to the Air tubing compliance guide in ResMed.com.





## Symbols



 Follow instructions before use.
  Indicates a warning or caution.
  Temperature limitation.



 Humidity limitation.
  Operating altitude.
  Atmospheric pressure limitation.
  Manufacturer.

 Direct current.
  Class II equipment.
  IP22 Protected against finger sized objects and against dripping water when tilted up to 15 degrees from specified orientation.
  Non-ionising radiation.

 MR unsafe (do not use in the vicinity of an MRI device).
  RTCA/DO-160 Section 21, Category M Compliant & FAA Compliant.
  Type BF applied part.
  Date of Manufacture
  Medical device.

 Catalogue number.
  Device number.
  Serial number.
  Batch code.

 European Authorised Representative.
  Bluetooth.
  Start therapy/Standby.

 Maximum water level.
  Open tub to fill.
  Importer.

See symbols glossary at ResMed.com/symbols.



### Environmental information

This device should be disposed of separately, not as unsorted municipal waste. To dispose of your device, you should use appropriate collection, reuse and recycling systems available in your region. The use of these collection, reuse and recycling systems is designed to reduce pressure on natural resources and prevent hazardous substances from damaging the environment.

If you need information on these disposal systems, please contact your local waste administration. The crossed-bin symbol invites you to use these disposal systems. If you require information on collection and disposal of your ResMed device please contact your ResMed office, local distributor or go to [ResMed.com/environment](http://ResMed.com/environment).

### Hazardous Materials information

Refer to the booklet packed with the device or refer to the Hazardous materials guide in [ResMed.com](http://ResMed.com).

## Servicing

The AirSense 11 device is intended to provide safe and reliable operation when operated in accordance with the instructions provided by ResMed. ResMed recommends that the AirSense 11 device be inspected and serviced by an authorised ResMed Service Centre if there is any sign of wear or concern with device function. Otherwise, service and inspection of the products generally should not be required during their design life.

## Limited Warranty

Our goods come with guarantees that cannot be excluded under the Australian and New Zealand Consumer Law. You are entitled to a replacement or refund for a major failure and for compensation for any other reasonably foreseeable loss or damage. You are also entitled to have the goods repaired or replaced if the goods fail to be of acceptable quality and the failure does not amount to a major failure.

In addition to your rights and remedies under the Australian and New Zealand Consumer Law (and any other applicable law), ResMed Pty Ltd ABN 30 003 765 142 of 1 Elizabeth Macarthur Drive, Bella Vista NSW 2153, (ResMed) warrants that your ResMed product will be free from defects in material and workmanship from the date of purchase for the period specified below:

Product	Warranty Period
Consumables:	
<ul style="list-style-type: none"> <li>AirTouch™, Ultra Soft memory foam cushion</li> <li>Acucare™ series</li> </ul>	7 days
<ul style="list-style-type: none"> <li>Mask systems (including mask frame, cushion, headgear and tubing) - excluding Consumables</li> <li>Accessories - excluding Consumables</li> <li>Flex-type finger pulse sensors</li> <li>Humidifier water tubs (non-reusable)</li> </ul>	90 days
<ul style="list-style-type: none"> <li>Batteries for use in ResMed internal and external battery systems</li> </ul>	6 months
<ul style="list-style-type: none"> <li>Clip type finger pulse sensors</li> <li>CPAP and bilevel device data modules</li> <li>DC/DC Converters</li> <li>Oximeters and CPAP and bilevel device oximeter adapters</li> <li>Humidifiers and humidifier water tubs (reusable)</li> <li>Titration control devices</li> </ul>	1 year
<ul style="list-style-type: none"> <li>CPAP, bilevel and ventilation devices (including external power supply units and excluding humidifier tubs)</li> <li>Battery accessories (including but not limited to DC cable, PSU adapter and coupler kit)</li> <li>Portable diagnostic/screening devices</li> </ul>	2 years

This warranty is only available to the initial consumer. It is not transferable.

During the warranty period, if the product fails under conditions of normal use, ResMed will repair or replace, at its option, the defective product or any of its components.

This limited warranty does not cover: a) any damage caused as a result of improper use, abuse, modification or alteration of the product; b) repairs carried out by any service organisation that has not been expressly authorised by ResMed to perform such repairs; c) any damage or contamination due to cigarette, pipe, cigar or other smoke; d) any damage caused by exposure to ozone, activated oxygen or other gases; and e) any damage caused by water being spilled on or into an electronic device.

Warranty is void on product sold, or resold, outside the region of original purchase.

Warranty claims on defective product must be made by the initial consumer at the point of purchase.

This warranty replaces all other expressed or implied warranties, including any implied warranty of merchantability or fitness for a particular purpose. Some regions or states do not allow limitations on how long an implied warranty lasts, so the above limitation may not apply to you.

ResMed shall not be responsible for any incidental or consequential damages claimed to have resulted from the sale, installation or use of any ResMed product. Some regions or states do not allow the exclusion or limitation of incidental or consequential damages, so the above limitation may not apply to you.

This warranty gives you specific legal rights, and you may also have other rights which vary from region to region. For further information on your warranty rights, contact your local ResMed dealer or ResMed office.

Visit [ResMed.com](http://ResMed.com) for the latest information on ResMed's Limited Warranty.

## **Further information**

If you require additional information on how to setup, use or maintain the Air11™ system (including ClimateLineAir 11 heated tubing), or to report unexpected operation or events, please contact the ResMed Service Centre or your care provider.



myAir™



**ResMed Pty Ltd**

MANUFACTURER 1 Elizabeth Macarthur Drive Bella Vista NSW 2153 Australia

See ResMed.com for other ResMed locations worldwide. AcuCare, Air11, AirSense, AirTouch, AutoSet, ClimateLine, ClimateLineAir, EPR, HumidAir, myAir, SlimLine and SmartStart are trademarks and/or registered trademarks of the ResMed family of companies. For patent and other intellectual property information, see ResMed.com/ip. SD Logo is a trademark of SD-3C, LLC. Google Play and the Google Play logo are trademarks of Google LLC. The Bluetooth® word mark and logos are registered trademarks owned by Bluetooth SIG, Inc. and any use of such marks by ResMed is under license. Apple and the Apple logo are trademarks of Apple Inc., registered in the U.S and other countries. App Store is a service mark of Apple Inc. registered in the U.S and other countries.

© 2023 ResMed. 398179/1 2023-03

**ResMed.com**



398179